

HS3A

Non-contact Interlock Switches

RFID technology for
higher level of safety



HS3A satisfies the requirements of:

EN/ISO 13849-1	Category 4 PL e
EN 62061 (Note)	SIL CL3

Note: EN 62061 is machine sector specific within the framework of EN 61508.

HS3A Non-contact Interlock Switches

New RFID non-contact interlock switch.
Category 4, PLe (ISO 13849-1) compliant.

HS3A satisfies the requirements of:

EN/ISO 13849-1	Category 4 PL e
EN 62061 (Note)	SIL CL3

Note: EN 62061 is machine sector specific within the framework of EN 61508.



Sensor Head
69.5 x 40.5 x 40.5 mm (actual size)



Safety Function

HS3A satisfies the requirements of PLe, Category 4, and SIL CL3. Does not require designated safety relay module or safety controller.

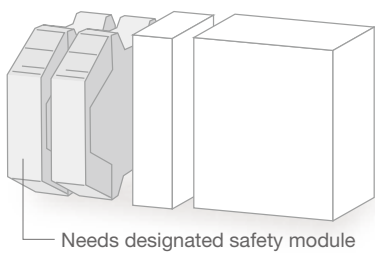

Conventional non-contact interlock switch



HS3A Non-contact Interlock Switch

No designated safety module required.

The HS3A non-contact interlock switches detect internal error automatically. Requires no designated safety relay module or safety controller. Compliant with Category 4 (EN/ISO 13849-1), PLe, and SIL CL3 (EN 62061).

FS1A Safety Controller

No programming required; all you need is selecting a logic! Reduces cost and wiring work.

See page 8.



International Standards Compliant

HS3A Non-contact Interlock Switch

Using the FS1A safety controller, various safety products can be connected easily to provide the best system solution.

Detection



Stable detection of slow moving doors

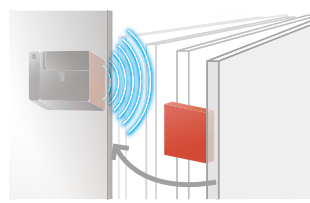

Hinged doors, sliding doors, and rattling doors can be detected

RFID ensures detection of slow-moving doors. (L-shaped mounting bracket must be supplied by the user.)

Clean Surface



RFID prevents the buildup of metal residue



Not RFID



RFID HS3A

Suitable for harsh environment applications

The nonmagnetic actuator is resistant against buildup of metal particles.

Identification



Tamper-proof (unicode model)

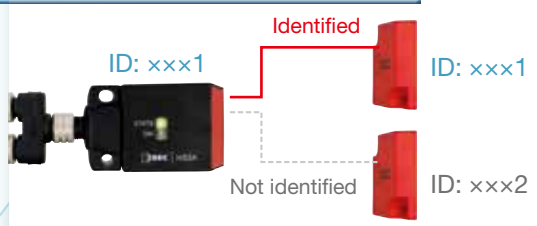

An actuator with an electronic code is assigned to a sensor head. This prevents tampering by using an unassigned spare actuator. For details, see "System Status Table" in the system manual B-1223.

Mounting

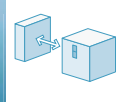

Can be installed in five directions

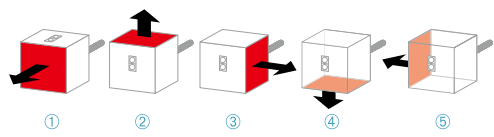

The interlock switch can be installed in five directions, allowing for flexible installation.

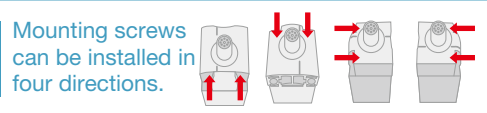

Mounting screws can be installed in four directions.

LED

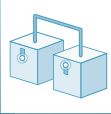

Door status indication

LED shows the error of doors connected in series

LED on the sensor head shows the door status. For details, see "System Status Table" in system manual B-1221 or B-1223.

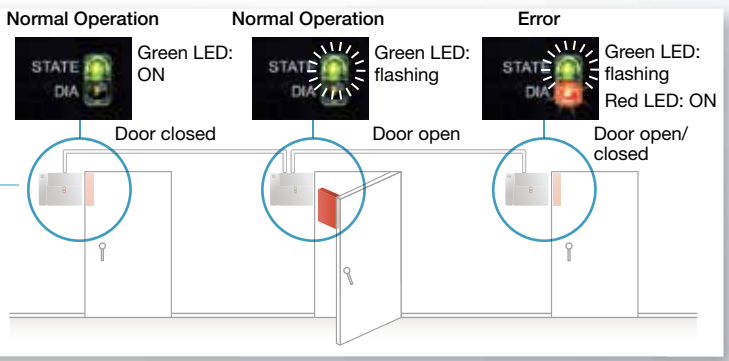

Actuator



Y-branch Connector

HS3A Non-contact Interlock Switches

RFID non-contact interlock switch, Category 4 and PLe (EN/ISO 13849-1) compliant.

- The sensor head with built-in safety function (redundant solid state output with internal monitoring) eliminates the need for a designated safety module.
- RFID ensures detection of slow-moving, open, sliding, and rattling doors.
- Multicode and unicode sensor heads are available. Unicode sensor head (one sensor head corresponds to one actuator) prevents tampering with the use of an unassigned spare actuator.
- Sensor head can be installed in 5 directions.
- RoHS compliant.
- Degree of protection IP67. Actuator IP67, IP69K (Note)

Note: IP69K is a degree of protection specified by Deutsches Institut für Normung (DIN), DW 40050 Part 9 for hot and high-pressure water.

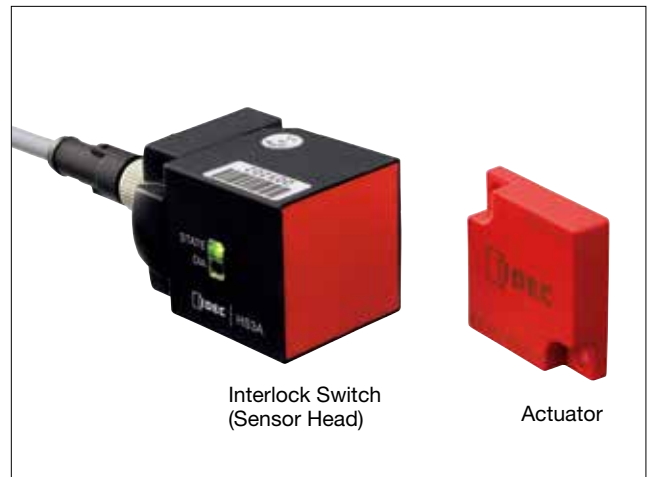

Interlock Switch (Sensor Head)

Actuator







HS3A Non-contact Interlock Switch (sensor head)

Outputs	Type	Part No. (Ordering No.)
Safety output: 2	Multicode	HS3A-H21M4
Monitor output: 1	Unicode	HS3A-H21U4

- Package quantity: 1
- Actuator (HS9Z-ZH31) is not supplied with the switch and must be ordered separately.



Accessories

Name	Part No. (Ordering No.)	Package Quantity	Remarks
Actuator 	HS9Z-ZH31	1	<ul style="list-style-type: none"> • Actuator for both multicode and unicode sensor heads. • Supplied with two M5 × 10 mounting screws (stainless steel)
Terminal Plug (For serial connection) 	HS9Z-H3TP	1	<ul style="list-style-type: none"> • Used on Y-branch connector when connecting two or more switches in series.
Y-branch Connector (For serial connection) 	HS9Z-H3YD	1	<ul style="list-style-type: none"> • Used when connecting two or more switches in series. • Plug connector: 8-pin (switch side), 5-pin (cable side)
M12 Plug Connection Cable 	5-pin, 5m	1	<ul style="list-style-type: none"> • Used when connecting two or more switches in series. • 5-pin plug connector is provided at one end.
	5-pin, 10m		
M12 Plug Connection Cable (For serial connection) 	8-pin, 5m	1	<ul style="list-style-type: none"> • Used when connecting a single switch. • 8-pin plug connector is provided at one end.
	8-pin, 10m		
M12 Plug Connection Cable (For serial connection) 	5-pin, 5m	1	<ul style="list-style-type: none"> • Used when connecting two or more switches in series. • 5-pin plug connectors are provided at both ends.
	5-pin, 10m		

- See below for an example of accessories required when connecting N number of HS3A switches in series.

HS3A non-contact interlock switch (HS3Z-H21*4): N pcs.

Actuator (HS9Z-ZH31): N pcs.

Terminal plug (HS9Z-H3TP): 1 pc.

Y-branch connector (HS9Z-H3YD): N pcs.

M12 plug connection cable, open end (HS9Z-H3F5**): 1 pc.

M12 plug connection cable, plug connectors at both ends (HS9Z-H3F5M**): N-1 pcs.

HS3A Non-contact Interlock Switches

Specifications

Applicable Standards	EN60947-5-3 (IFA approval) EN954-1, EN ISO13849-1, EN62061 GS-ET-14 (IFA approval) UL508 (UL listed) CSA C22.2 No.14 (c-UL listed)
Operating Temperature	-20 to +55°C (no freezing)
Relative Humidity	5 to 80% (no condensation)
Storage Temperature	-25 to +70°C
Pollution Degree	3
Sensor Classification	PDF-M (EN60947-5-3)
Performance Level (PL)	e (EN ISO 13849-1)
Safety Category	4 (EN ISO 13849-1)
Safety Integrity Level (SIL)	3 (EN 62061)
Type (EN ISO14119)	Type 4
Levels of Coding (EN ISO14119)	Unicode: high level coded Multicode: low level coded
Degree of Protection	Interlock Switch (sensor head) IP67 Actuator IP67, IP69K (Note)
Rated Voltage (U _B)	24V DC ±15%
Current Consumption	80mA (at no load)
Dielectric Strength	500V AC
Output Specifications	Safety Output: Semiconductor output, P-channel Output voltage: Max: U _B [V], Min.: U _B -1.5 [V] Maximum output current per safety output: 400 mA Monitor Output: Semiconductor output, P-channel Output voltage: Max: U _B [V], Min.: 0.8×U _B [V] Maximum output current: 200 mA
Operation Distance	Turn-on Distance: 15 mm (typ.) Assured Turn-on Distance (Sao): 13 mm Maximum Turn-off Distance (Sar): 58 mm
Response Time	When using a single switch: 260 ms (actuator removed) 150 ms (non-identical input signal at IA/IB) 150 ms (non-identical enabling input state at IA/IB) 300 ms (short-circuit or cross-circuit at OA/OB, or internal error) When using two or more switches (max.): 360 ms (actuator removed) 250 ms (non-identical input signal at IA/IB) 400 ms (non-identical enabling input state at IA/IB) 400 ms (short-circuit or cross-circuit at OA/OB, or internal error)
Shock Resistance	Operating extremes: 300 m/s ² (11 ms)
Vibration Resistance	10 to 55 Hz, amplitude 0.5 mm
Material	PBT
Cable	M12 plug connection cable, 8-pin
Weight (approx.)	400g (HS3A-H21**)
Attachment	System Manual (CD-ROM)

Note: IP69K is a degree of protection specified by Deutsches Institut für Normung (DIN), DW 40050 Part 9 for hot and high-pressure water.

Dimensions

Sensor Head

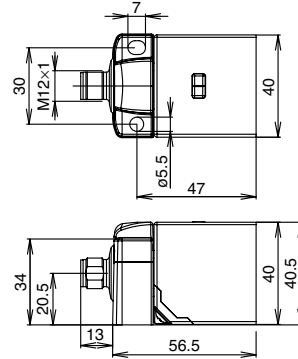

Actuator

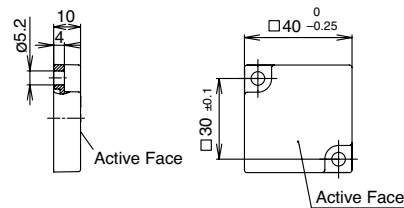

Supplied with two mounting screws (M5 × 10).

Terminal Plug HS9Z-H3TP

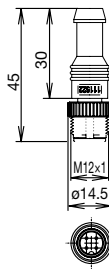

Y-branch Connector HS9Z-H3YD

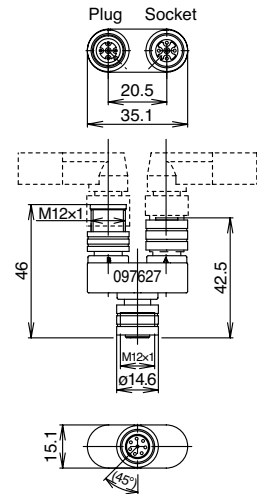

All dimensions in mm.

Plug Connection Cable Colors

HS9Z-H3F8

Pin	Wire	Legend	Description
1	White	IB	Enabling input (channel 2)
2	Brown	UB	Power supply (24V DC)
3	Green	OA	Safety output (channel 1)
4	Yellow	OB	Safety output (channel 2)
5	Gray	OUT	Monitoring output
6	Pink	IA	Enabling input (channel 1)
7	Blue	0V	0V
8	Red	RST	Reset input for hardware

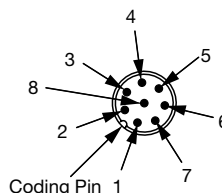

HS9Z-H3F5

Pin	Wire	Legend
1	Brown	UB
2	White	OA
3	Blue	0V
4	Black	OB
5	Gray	RST

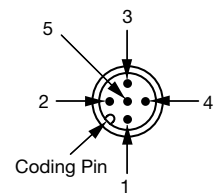

HS3A Non-contact Interlock Switches

Wiring Diagram

When using a single HS3A (Category 4 example)

When using a single HS3A, connect as shown in the figure below (Note). The OUT output can be connected to a control system, to a PLC for example, as a monitoring output.

The HS3A can be reset via the RST input. To reset, apply 24V DC for at least 3 seconds. When not using the RST input, connect the RST input to 0V.

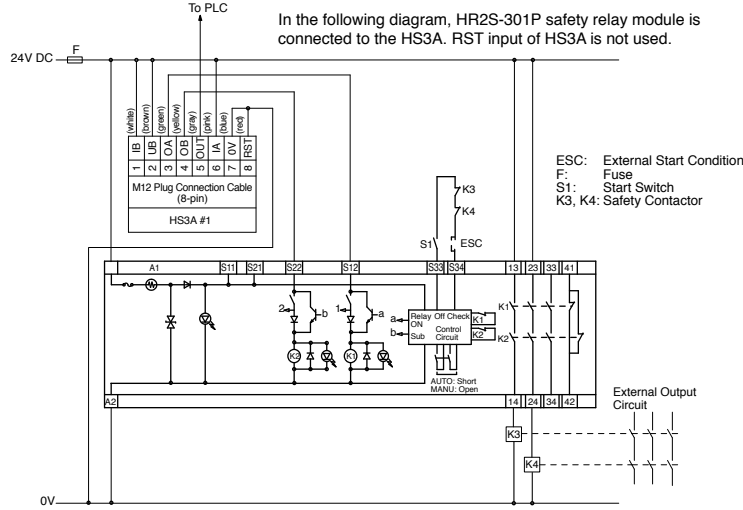

For details of HR2S-301P safety relay module, see the instruction sheet.

When using two or more HS3A in series (Category 4 example)

- A maximum of 20 can be connected in series.
- Pay attention to the contact resistance at the connection points.

The HS3A switches can be connected in series using plug connection cables and Y-branch connectors as shown in the figure below (Note). When any of the HS3A switches detects that the safety guard is open, or when a failure has occurred on any of the switches, the system turns off the machine. However, the external control system cannot detect which safety guard is open or where a failure has occurred.

The HS3A can be reset via the RST input. To reset, apply 24V DC for at least 3 seconds. When not using the RST input, connect the RST input to 0V.

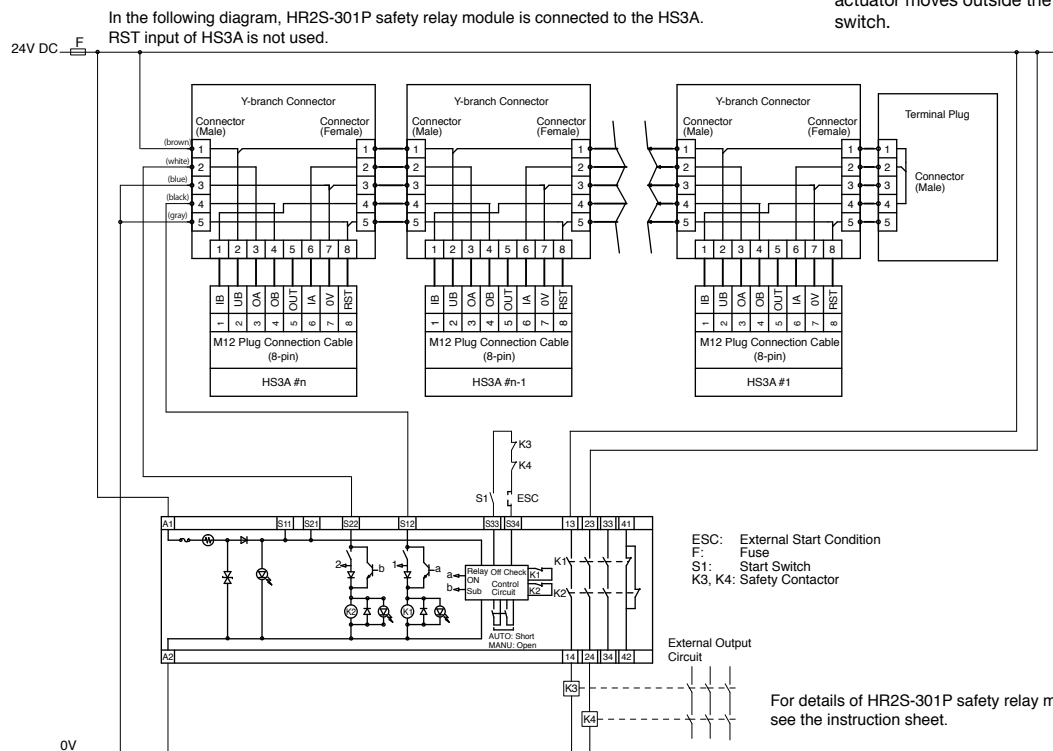

Safety Output Response Time

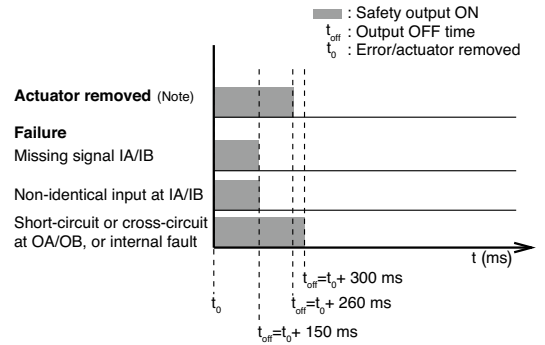

Note: The time required for the safety output to turn off after the actuator moves outside the operating distance of the HS3A switch.

Safety Output Response Time

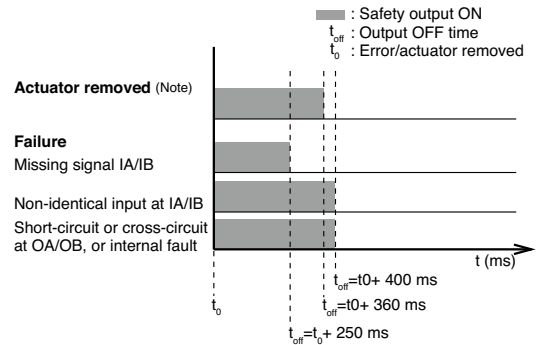

Note: The time required for the safety output to turn off after the actuator moves outside the operating distance of the HS3A switch.

HS3A Non-contact Interlock Switches



Safety Precautions

- Read the instruction manual before installation and wiring of the HS3A non-contact interlock switch. Observe the safety standards and regulations of relevant countries and regions where operating the HS3A. Perform a risk assessment before operation.
- Do not disassemble, modify, or repair the HS3A. Also do not disable the safety function of the interlock switch, otherwise failure or accident will occur.
- In order to avoid electric shocks or fire, turn power off to the HS3A before installation, removal, wiring, maintenance, or inspection.
- The HS3A has functions to ensure operators' safety. Make sure that the interlock switch is installed correctly, and that safety functions are not disabled. Otherwise serious injury may occur. Check the safety function of each door. Also, perform checks periodically according to a maintenance schedule.
 - When starting up the system
 - When replacing the sensor head or accessories
 - When the system has not been operated for a prolonged period of time.

Instructions

- Do not store the HS3A in a dusty, humid, organic-gas atmosphere, or areas subject to direct sunlight.
- Regardless of door types, do not use the HS3A as a door stop. Install a mechanical door stop on the edge of the door to protect the interlock switch against excessive force.
- Do not apply excessive force to the HS3A. A shock to the door exceeding 300 m/s^2 may cause a failure to the switch (shock resistance 300 m/s^2)
- Be sure to use the HS3A in combination with the proper accessories and connection cable.
- The HS3A may only be installed and operated by personnel who are skilled/familiar with the followings:
 - Operation of safety products
 - Relevant EMC standards
 - Relevant regulations and standards of safety and health
 - Descriptions in instruction sheet and system manual
- Check the following daily in order to ensure correct operation and long service life of the HS3A.
 - ON/OFF of safety outputs
 - Wiring and installation of connected equipment
 - Clean and free from smudge

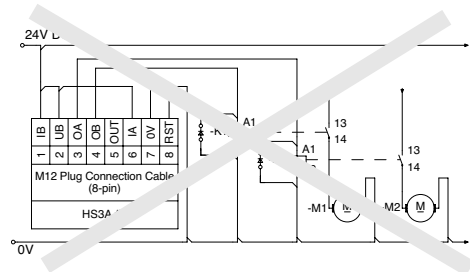

Mounting Screws Recommended Torque

- Sensor head: 1 N·m (M5)
- Actuator: 1 N·m (M5)
 - Mounting screws are not supplied with the sensor head and must be provided by the user.
 - Use the actuator mounting screws supplied with the HS3A. When using other screws, use stainless steel or nonmetallic screws. Otherwise operating distance may be affected.

Operation Distance and Response Time

- When installing the HS3A, ensure the safety of the door opening area by paying attention to the operation distance (Table 1) and response time (Table 2) shown below.

Table 1: Operation Distance (Note 1)

Distance	Value (mm)		
	Min.	Typ.	Max.
Turn-on distance	—	15 (Note 2)	—
Assured turn-on distance S_{a0}	13	—	—
Switching hysteresis	1.5	2.5	—
Assured turn-off distance S_{ar}	—	—	58

Note 1: When the off-center displacement of the interlock switch (sensor head) and actuator is 0 mm.

Note 2: When surface-mounted on aluminum. When using by embedding in metal, pay attention to the operation distance affected by the metal. In non-metallic environment, the typical turn-on distance increases to 30mm.

Table 2: Response Time

Response Time		260 ms (actuator removed)	
		When connecting a single switch (max.)	150 ms (missing enabling input IA/IB)
When connecting two or more switches (max.)		300 ms (short-circuit or cross-circuit at OA/OB, or internal fault)	
		360 ms (actuator removed)	
		250 ms (missing signal enabling input IA/IB)	400 ms (non-identical enabling input state at IA/IB)
		400 ms (short-circuit or cross circuit at OA/OB or internal fault)	

Note: To ensure safety, both safety outputs (OA and OB) must always be evaluated. Single-channel use of the safety outputs as shown below leads to a reduction of safety category stipulated in EN954-1.

- Do not use the monitor output (OUT) as a safety output.
- The HS3A supplies +24V to dual safety outputs while in turn-on state. Inputs of the connected safety controller and safety PLC must be positive-switching.
- All electrical connections must either be isolated from the main power supply by a safety transformer according to EN IEC 61558-2-6 with limited output voltage in the event of a fault, or by other equivalent isolation measures.
- Use a power supply rated for Class 2 circuits or of equivalent function.
- All electrical outputs, including monitor outputs, must have an adequate protective circuit for inductive loads. Protecting of the outputs using a free-wheeling diode is recommended.
- Power devices which can cause interference must be installed away from the input and output circuits for signal processing. Provide sufficient distance between the wirings of safety circuits and power circuits.
- Use the HS3A with the proprietary actuator (HS9Z-ZH31) only, and do not use any other actuator.
- Provide the power supply with fuse protection depending on the number of sensor heads and the required output current. For details, refer to "Fuse protection for power supply" in system manual B-1223.
- The HS3A switch generates its own pulses (up to 1 ms) on the safety outputs OA and OB for confirming the safety function. Use a downstream control system that tolerates these test pulses. When using a system with pulsing function, defeat the pulsing function. Note that pulse is generated even when the safety output is off.
- When installing the HS3A switches adjacently, provide at least 80 mm intervals to avoid mutual interference.

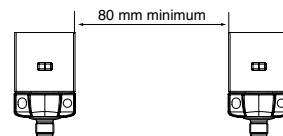

Operating distance can be affected by the operating environment. Check the actual operating distance before installing the HS3A switch and actuator.

- Do not exert excessive force, twist or pull on the connection cable, otherwise the cable may be broken.
- The maximum total cable length is 200 m for connecting two or more HS3A switches in series.

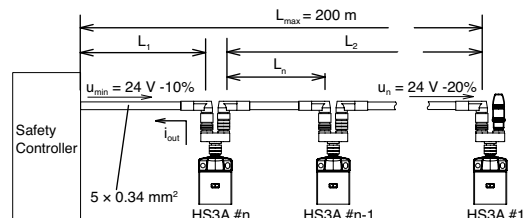

- After installing the HS3A, check function and operation.
- For teach-in procedure of HS3A-H21U4 (unicode), refer to system manual B-1223.

HS3A Non-contact Interlock Switches

Instructions

Operating Area (typical data)

(When using the HS3A non-contact interlock switch in combination with a surface-mounted actuator HS9Z-ZH31)

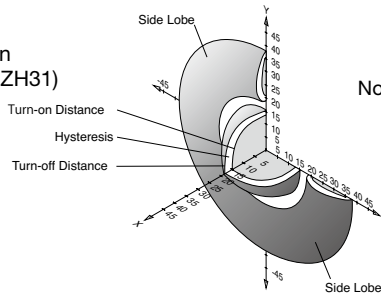

Note: To avoid entering the area of possible side lobes, a minimum distance of 6 mm between the active surface of the HS3A switch and the actuator must be maintained in case of an approach from the side.

Connecting HS3A Non-contact Interlock Switch to an FS1A Safety Controller

HS3A non-contact interlock switches can be connected to the FS1A safety controller (FS1A-C11S/FS1A-C21S). Connect OA and OB safety outputs to the dual channel safety input of FS1A.

For more details of the FS1A, see the user's manual at <http://www.idec.com/download/>.

Connection example to logic No. 11C of FS1A-C11S (category 4 example) (Note)

The following safety products are used in this example. HS3A non-contact interlock switch (1 pc.), light curtain (1 pc.), emergency stop switch (2 pcs.), interlock switch with solenoid (spring lock) (2 pcs.)

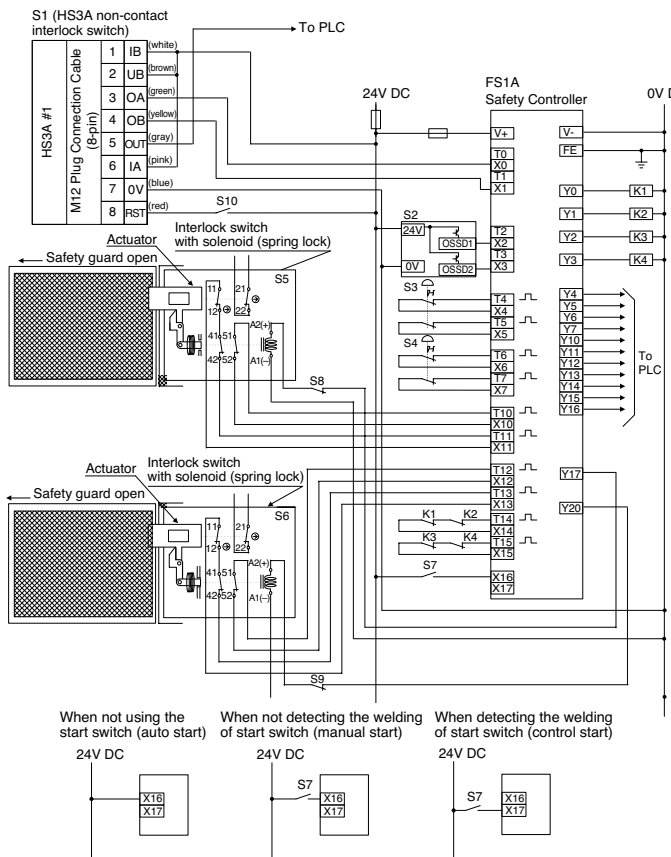

- S1: HS3A non-contact interlock switch
- S2: Light curtain
- S3, 4: Emergency stop switch
- S5, 6: Interlock switch with solenoid (spring lock)
- S7: Start switch
- S8, 9: Solenoid control switch
(Pressing this switch after closing the safety guard turns on 41-42 and 51-52 of S5 or S6, enabling the FS1A to restart.)
- S10: RST input switch of HS3A non-contact interlock switch
- K1 to 4: Contactor
- M1, 2: Motor

Logic Circuit using FS1A-C11S safety controller logic No. 11C

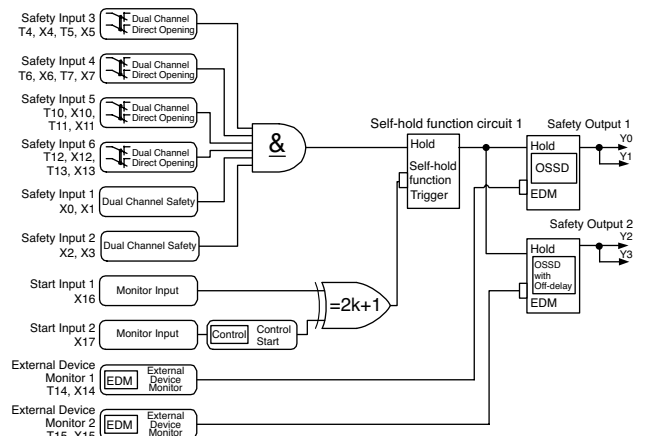

Note: In actual system or equipment, various factors such as hazard type, safeguarding measure, and danger level depending on operation modes need to be taken into consideration for risk assessment, in order to reduce the risk to an acceptable level. Therefore, safety category must be evaluated on the entire safety related system.

For the time chart of logic no. 11C, see the user's manual of FS1A-C11S safety controller (<http://www.idec.com/download/>).

Specifications and other descriptions in this brochure are subject to change without notice.



IDEC CORPORATION

IDEC CORPORATION (USA)
 Tel: +1-408-747-0550 / (800) 262-IDEC (4332)
 E-mail: opencontact@idec.com
IDEC CANADA LIMITED
 Tel: +1-905-890-8561, Toll Free: (888) 262-IDEC (4332)
 E-mail: sales@ca.idec.com
IDEC AUSTRALIA PTY. LTD.
 Tel: +61-3-8523-5900, Toll Free: 1800-68-4332
 E-mail: sales@au.idec.com

IDEC ELEKTROTECHNIK GmbH
 Tel: +49-40-25 30 54 - 0 E-mail: service@eu.idec.com
IDEC (SHANGHAI) CORPORATION
 Tel: +86-21-6135-1515 E-mail: idec@cn.idec.com
IDEC (BEIJING) CORPORATION
 Tel: +86-10-6581-6131
IDEC (SHENZHEN) CORPORATION
 Tel: +86-755-8356-2977

IDEC IZUMI (H.K.) CO., LTD.
 Tel: +852-2803-8989 E-mail: info@hk.idec.com
IDEC TAIWAN CORPORATION
 Tel: +886-2-2698-3929 E-mail: service@tw.idec.com
IDEC IZUMI ASIA PTE. LTD.
 Tel: +65-6746-1155 E-mail: info@sg.idec.com
IDEC ASIA (THAILAND) CO.,LTD.
 Tel: +662-392-9765, E-mail: sales@th.idec.com

6-64, Nishi-Miyahara 2-Chome, Yodogawa-ku, Osaka 532-0004, Japan
Tel: +81-6-6398-2571, Fax: +81-6-6392-9731, E-mail: marketing@idec.co.jp